

# PAUL™ & PAULETTE™

Projecteurs LED  
LED projectors

Compatible avec / with :

Tous nos mâts support projecteurs / all our poles: Structure K, Aiguille, Bermude, Octave

Toutes nos colonnes (éclairage interne ou additionnel) / all our columns (internal or additional lighting): Treille, Creille (GM), Creille qui Pousse

## Description

- Gamme de projecteurs carrés (Paul) ou ronds (Paulette), déclinée spécifiquement pour l'éclairage architectural ou l'éclairage routier
- Gamme «Architectural» disponible en 3 tailles différentes et offrant un large panel de couleurs (blancs, blanc dynamique, RGB white)
- Gamme «Routier» disponible en 2 tailles différentes
- Corps et fixation en aluminium
- Garantie 2 ans

## Description

- Range of floodlights: square-shape (Paul) or round-shape (Paulette), available for architectural or roadway lighting
- «Architectural» range available in 3 different sizes and offering a large color panel (whites, dynamic white, RGB white)
- «Roadway» range available in 2 different sizes
- Body and mounting fixtures in aluminum
- 2 year guarantee



Modèle / model: Paul



Modèle / model: Paulette

## Informations techniques / Technical specifications

	ARCHITECTURAL			ROUTIER / STREET	
	S	M	L	M	L
Taille / Size					
Nombre de LED / number of LED	16	24	36	16	36
Puissance / Power	18 W	27 W	37 W	24 W	37 W
Flux sortant / Outflow (3000°K)	1500 lm	2300 lm	3100 lm	2970 lm	4165 lm
T° de couleur / Color t°	2200, 2700, 3000, 4000 °K Dynamic white (2200-4000°K), RGB white			2200, 2700, 3000, 4000 °K	
IRC / CRI	>70				
Indice de protection / Protection	IP 65 / IK 08				
Classe / Class	I (II possible)				
Durée de vie / Lifespan (L80B10)	> 100 000				
Driver	Pilotage DALI, DMX (sur demande / upon request)				

## Photometries / Photometry

Autres photométries sur demande  
Other photometrics upon request

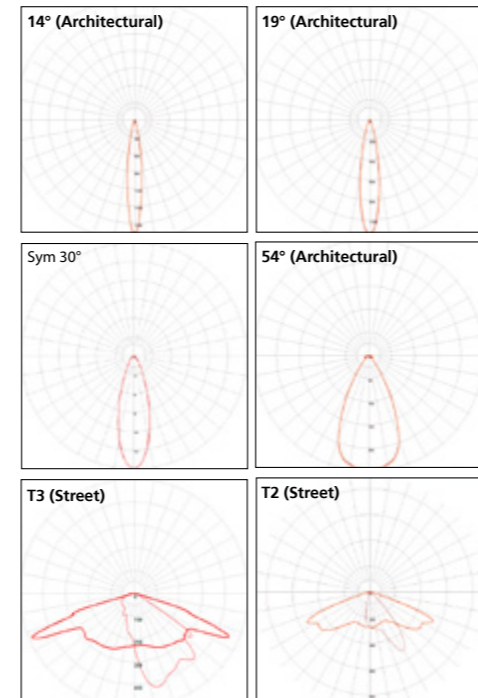

● PHOTOMÉTRIES (IES, LDT) →

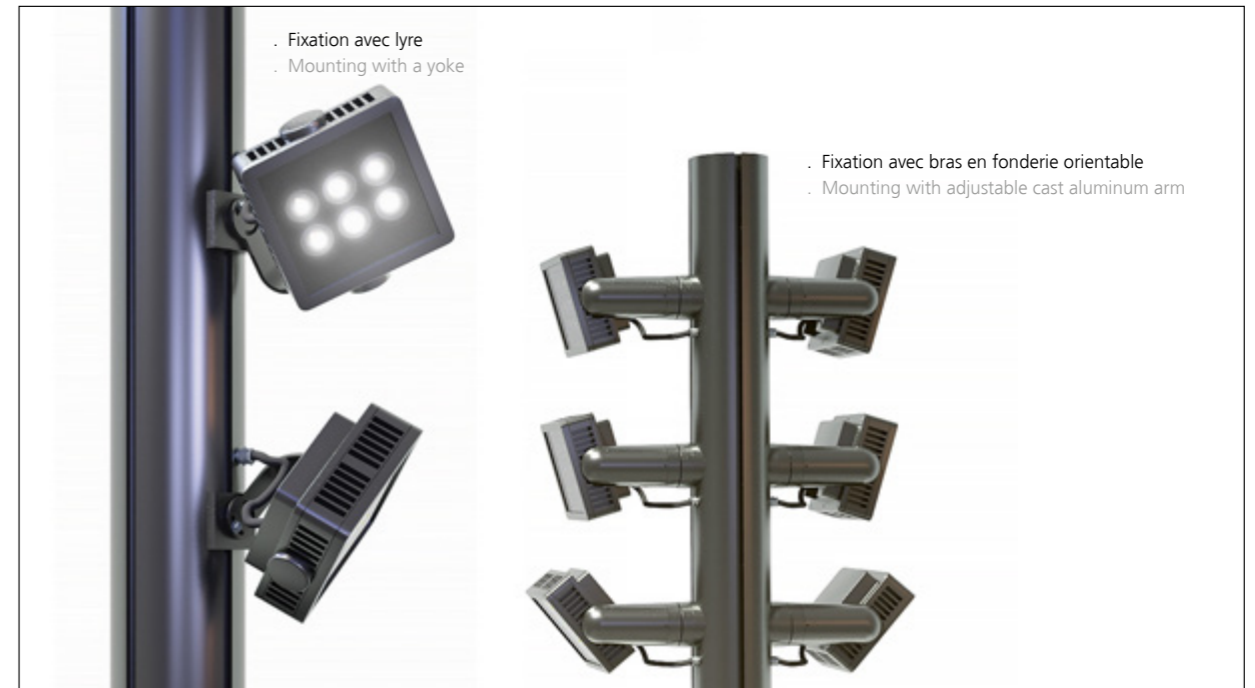

Paul & Paulette S



Avec lyre / with yoke  
190 x 180 x 100 mm  
Avec bras / with arm  
270 x 210 x 100 mm

Paul & Paulette M



Avec lyre / with yoke  
210 x 200 x 100 mm  
Avec bras / with arm  
280 x 230 x 100 mm

Paul & Paulette L

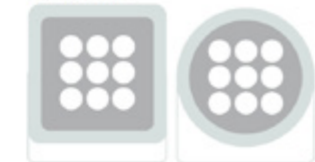

Avec lyre / with yoke  
260 x 240 x 110 mm  
Avec bras / with arm  
300 x 270 x 110 mm



# PAULETTE XL™

Projecteurs LED  
LED projectors

Compatible avec / with :

Tous nos mâts support projecteurs / all our poles: Structure K, Aiguille, Bermude, Octave, Manseng, Mikado, Shiraz

## Description

Projecteur rond, décliné spécifiquement pour l'éclairage architectural ou l'éclairage routier

Gamme «Architectural» offrant un large panel de couleurs (blancs, blanc dynamique, RGB white)

Gamme «Routier»

## Description

Round-shape floodlight, available for architectural or roadway lighting

«Architectural» range offering a large color panel (whites, dynamic white, RGB white)

«Roadway» range

Body and mounting fixtures in aluminum

2 year guarantee



Modèle / model: Paulette XL Architectural



Modèle / model: Paulette XL routier / street

## Informations techniques / Technical specifications

Gamme / Range	ARCHITECTURAL	ROUTIER / STREET
Nombre de LED / Number of LED	48	32
Puissance / Power	50 W	66 W
Flux sortant / Outflow (3000°K)	4200 lm	8050 lm
T° de couleur / Color T°	2200, 2700, 3000, 4000 °K Dynamic white (2200-3000°K), RGBW	2200, 2700, 3000, 4000 °K
IRC / CRI	>70	
Indice de protection / Protection	IP 65 / IK 08	
Classe / Class	I (II possible)	
Durée de vie / Lifespan (L80B10)	> 100.000	
Driver	Pilotable DALI, DMX, programmation horaire (sur demande / upon request)	

Autres photométries sur demande  
Photometries / Photometry Other photometrics upon request

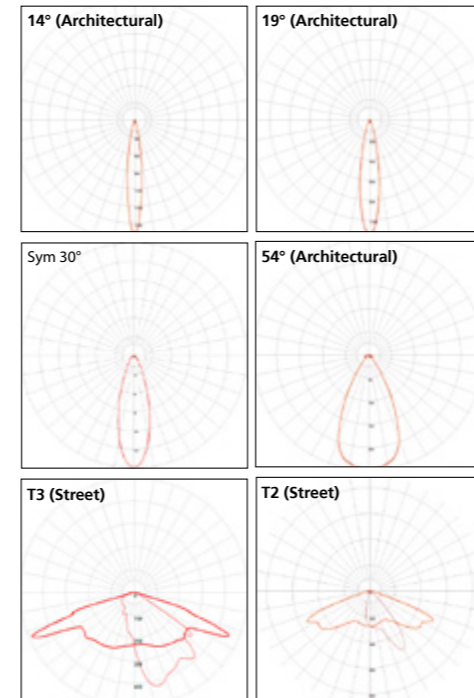

● PHOTOMÉTRIES (IES, LDT) →

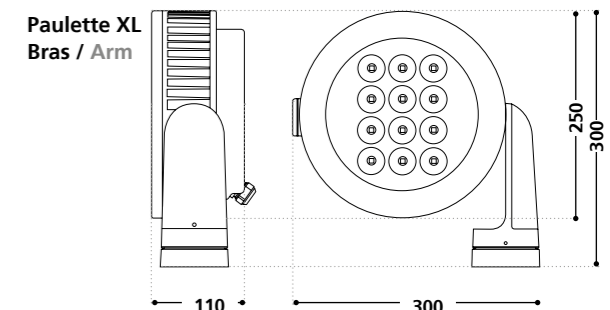
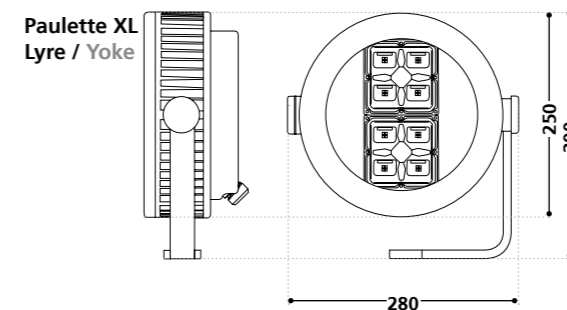

# ACCESSOIRES PAUL™ & PAULETTE™

Accessories

## Casquette Visor

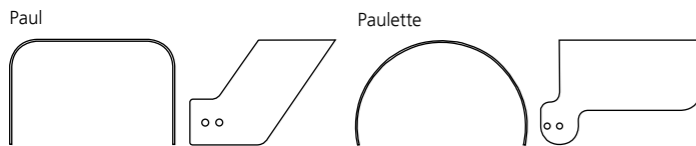

- Pièce en aluminium thermolaquée
- Accessoire livré non monté sur le projecteur

- Powder-coated aluminum part
- Accessory delivered not mounted on the projector

**ATTENTION !**  
Accessoire ayant un impact sur les courbes photométriques

**WARNING !**  
Accessory having an impact on photometric distribution

## Canon Snoot

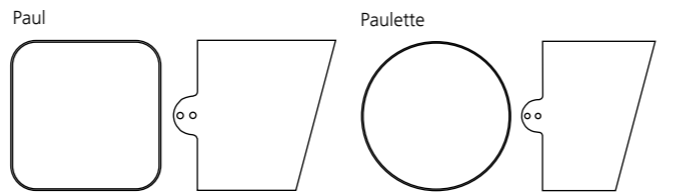
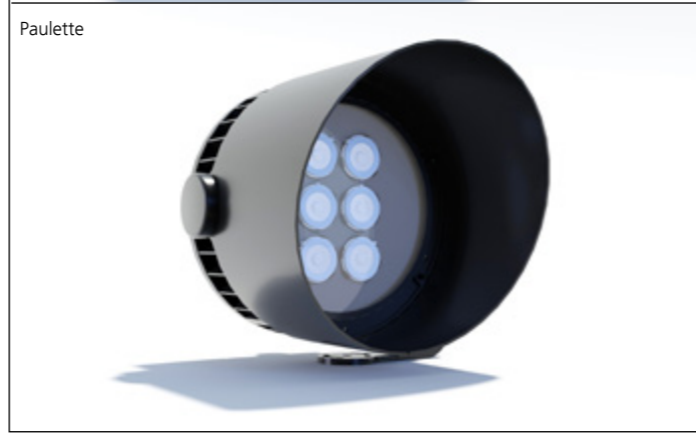

- Pièce en aluminium thermolaquée
- Accessoire livré non monté sur le projecteur

- Powder-coated aluminum part
- Accessory delivered not mounted on the projector

**ATTENTION !**  
Accessoire ayant un impact sur les courbes photométriques

**WARNING !**  
Accessory having an impact on photometric distribution

## Grille de défilement Wire Guard

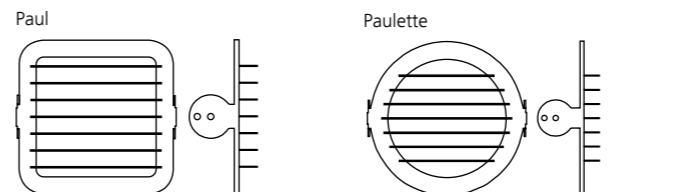
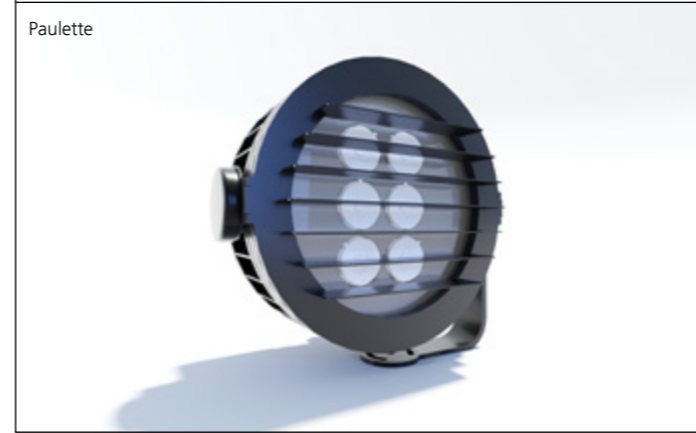
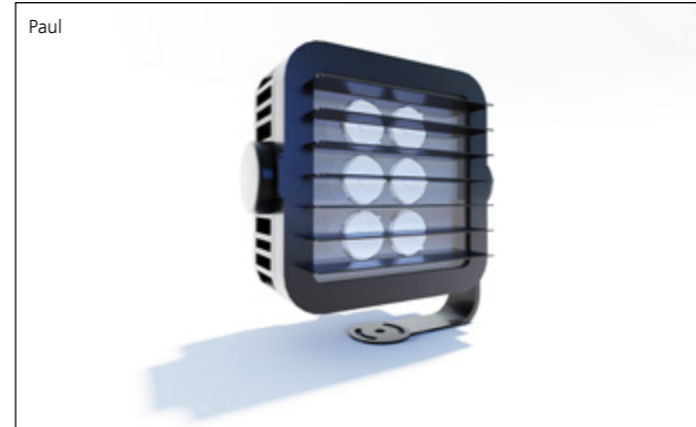

- Pièce en aluminium thermolaquée
- Accessoire livré non monté sur le projecteur
- Non réglable

- Powder-coated aluminum part
- Accessory delivered not mounted on the projector
- Not adjustable

**ATTENTION !**  
Accessoire ayant un impact sur les courbes photométriques

**WARNING !**  
Accessory having an impact on photometric distribution

## Nid d'Abeille Honey Comb

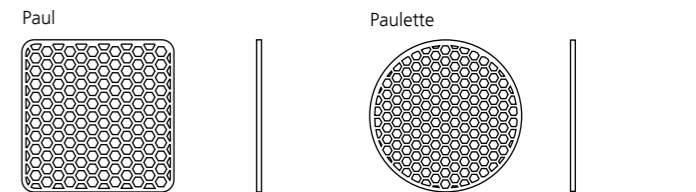
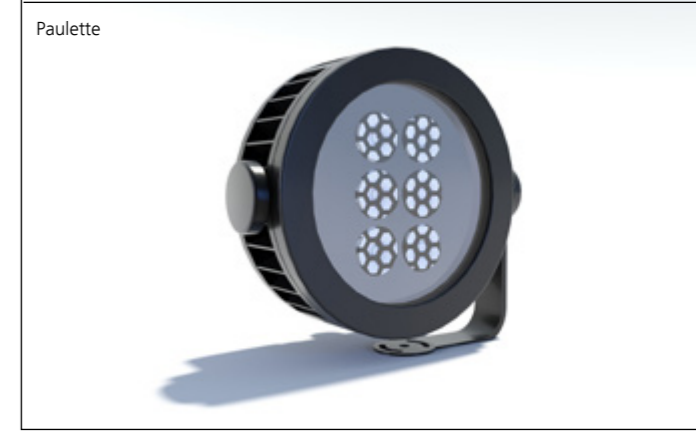

- Pièce en aluminium anodisée noir
- Accessoire livré monté sur le projecteur
- Disponible uniquement sur la gamme architecturale

- Black anodized aluminum part
- Accessory delivered mounted on the projector
- Available only on the architectural range

**ATTENTION !**  
Accessoire ayant un impact sur les courbes photométriques

**WARNING !**  
Accessory having an impact on photometric distribution

\* Visuels des accessoires sur Paul & Paulette taille M  
\* Visuals of accessories on Paul & Paulette size M



# PAULETTE™

Projecteurs LED  
LED projectors

↓ **Carnon, Esplanade du Port (FR)**  
Maîtrise d'ouvrage / Contracting authority:  
Commune de Mauguio-Carnon, L'Or  
Aménagement  
Architecte / Architect:  
Gautier Conquet & Associés  
Concepteur lumière / Lighting design:  
Les Eclaireurs  
Paysagiste / Landscape architect:  
APS Paysagiste  
Bureau d'études / Engineering:  
Egis Ville & Transport

© Hugo Da Costa

→ **Cazouls-Lès-Béziers, Place des 140 (FR)**  
Maîtrise d'ouvrage / Contracting authority:  
Mairie de Cazouls-Lès-Béziers, Régie Municipale  
de Cazouls-Lès-Béziers  
Architecte / Architect:  
Passelac & Roques, Atelier d'architecture Serra  
Paysagiste / Landscape architect:  
Agence Ginjaume Paysage  
Bureau d'études / Engineering:  
BE2T Ingénierie

© Hugo Da Costa





# PAULETTE™

Projecteurs LED  
LED projectors

↓ **Bellegarde, Pôle Culturel & associatif Elie Bataille (FR)**  
Maîtrise d'ouvrage / Contracting authority:  
Ville de Bellegarde, GGL Aménagement,  
Communauté de Communes Beaucaire Terre  
d'Argence  
Architecte / Architect:  
Tautem architecture  
Concepteur lumière / Lighting design:  
RVB Lighting  
Bureau d'études / Engineering:  
Adret & Seri

© Hugo Da Costa

→ **Alfortville, Centre culturel «Le148» (FR)**  
Maîtrise d'ouvrage / Contracting authority:  
Ville d'Alfortville  
Architecte / Architect:  
WAW Architects  
Bureau d'études / Engineering:  
DS2E

© MFL Photo pour WAW Architects

