



STRUCTURE K

[Disposition, agencement des parties (d'un bâtiment, d'une œuvre)]
Mât support projecteurs de section ronde, avec rails techniques intégrés permettant la fixation aisée d'éléments lumineux ou de tous types d'accessoires.

[Layout, arrangement of parts (of a building, a work)]
Event pole equipped with technical grooves for easy mounting of floodlights and accessories.

← Le Grau-Du-Roi,
Esplanade de la Mer (FR)
Maîtrise d'ouvrage / Contracting authority:
Ville du Grau-du-Roi
Architecte / Architect: C+D

© Marie-Caroline Lucat

STRUCTURE K

Construction en aluminium / Intégralement sans soudure
Aluminum made / Entirely weld-free

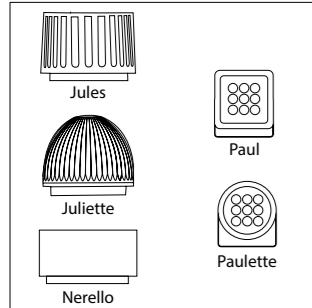

Luminaire

- Compatible luminaires Magic™, enveloppe Ceramic (Jules, Juliette) ou Nerello (<6 m)
- Compatible projecteurs Paul™ & Paulette™
- Compatible autres luminaires et projecteurs

Luminaire

- Compatible with Magic™ luminaire, Ceramic (Jules, Juliette) & Nerello envelope (<6 m)
- Compatible with Paul™ & Paulette™ floodlights
- Compatible with other luminaires and floodlights

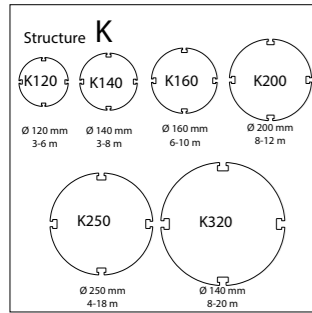

Mât

- Hauteurs de 4 à 21 m
- Profil aluminium exclusif avec structure interne fonctionnelle et rails techniques externes pour faciliter l'accessoirisation

Mast

- Heights from 4 to 21 m
- Exclusive aluminum profile with internal functional structure and external technical grooves to facilitate accessorization

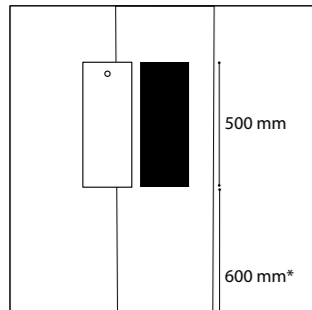

Porte de visite

- Affleurante, interchangeable
- Fermeture par vis inviolable
- Dimensions selon profil (voir p 208)

Access door

- Flush, interchangeable
- Locked with tamper-proof screw
- Dimensions according to profile (p 208)

*Autre hauteur sur demande
Other heights upon request

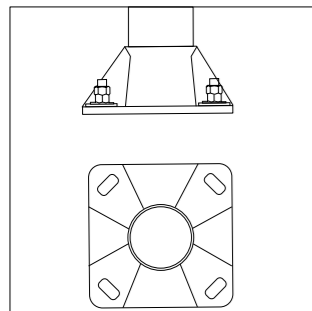

Semelle

- En fonderie d'aluminium
- Bagues isolantes au droit des 4 oblongs d'ancrage pour éviter tout contact avec les tiges en acier galvanisé
- Dimensions selon profil et hauteur (p 208)

Baseplate

- Made of die-cast aluminum
- Insulating rings on the 4 anchoring oblongs to avoid any contact with galvanized steel bolts
- Dimensions according to height and profile (p 208)

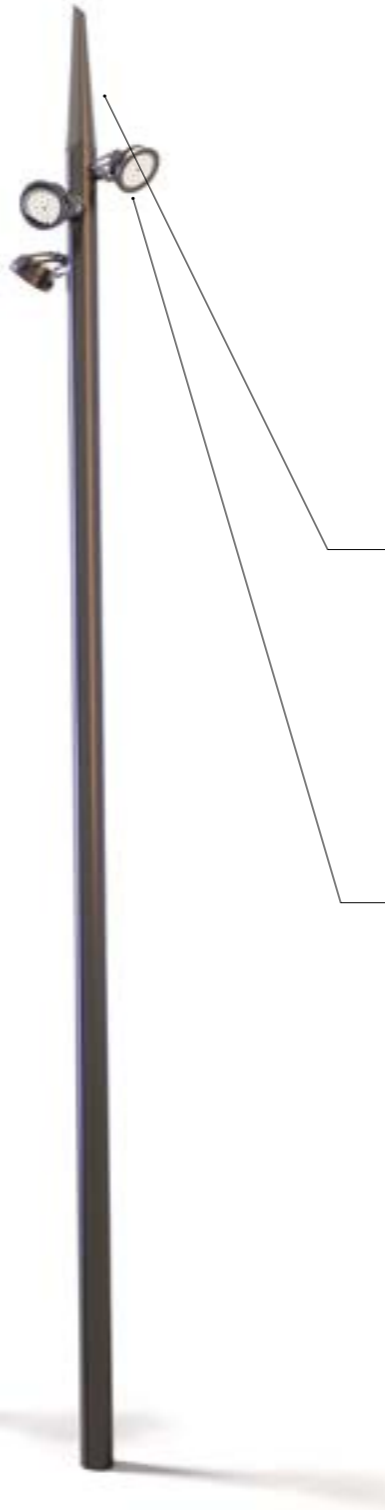

Tête de mât

- Fermeture du mât avec bouchon affleurant ou dispositif lumineux
- En top de mât : Aiguille, rehausses Fino (biseautée) ou Palino (rail technique hélicoïdal)

Mast top

- Top closing with flush plug or lighting system
- At the top of the pole: spike, conical extension piece (Fino), or Palino system (helicoïdal technical groove)

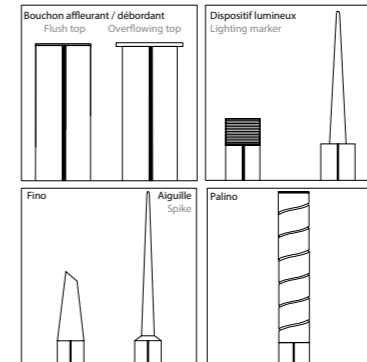

Projecteurs Paul / Paulette

- 4 tailles différentes
- Large gamme photométrique (optiques routières ou architecturales)
- Disponible en RVB ou blanc dynamique
- Pilotage DALI, DMX sur demande

Paule / Paulette floodlights

- 4 different sizes
- Large photometric panel (road or architectural)
- Available in RGB or dynamic
- DALI, DMX on demand



Luminaire LED Magic

- 35W
- 2200, 2700, 3000, 4000 ° K
- 3591 lm
- Pilotage DALI, 0-10 V sur demande

Dizeo LED fixture

- 35W
- 2200, 2700, 3000, 4000 ° K
- 3591 lm
- Pilotage DALI, 0-10 V upon request

La Grande-Motte, Front de mer (FR)
Maîtrise d'ouvrage / Contracting authority: Ville de la Grande Motte, Agglomération Pays de l'Or
Paysagiste / Landscape architect: Agence Guillermin - Architectes Paysagistes
Conception lumière / Lighting designer: Aurel Design Urbain
Bureau d'études / Engineering: Gaxieu Ingénierie

© Hugo Da Costa

+ Finition

- Thermolaquage par poudre Polyester, coloris RAL ou finitions spéciales
 - Anodisation (20 microns)
- Finish
- Polyester powder coating, RAL colors or special finish
 - Natural anodization (20 microns)

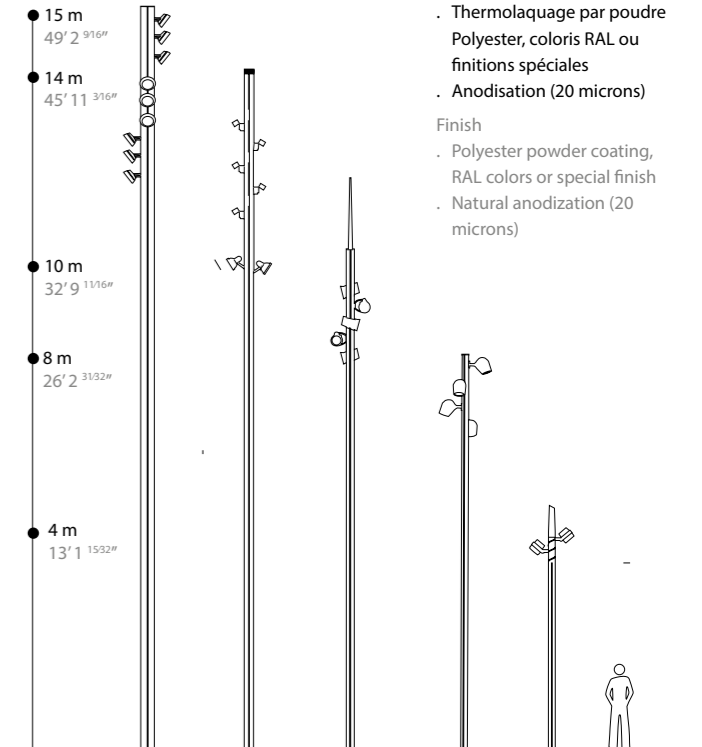

STRUCTURE K

↓ Menton, Esplanade des Sablettes (FR)
Maîtrise d'ouvrage / Contracting authority:
Ville de Menton
Architecte-paysagiste / Architect &
Landscape: Vincent Guillermin
Conception lumière / Lighting designer:
Studio Aurel
Bureau d'études / Engineering: A&TU

© Grégoire Edouard

→ New York City, High Line (USA)
Maîtrise d'ouvrage / Contracting authority:
Authority of New York
Architecte / Architect:
Diller Scofidio + Renfro
Paysagiste / Landscape architect:
James Corner Field Operations
Concepteur lumière / Lighting design:
L'Observatoire International

© AJJN Photography



STRUCTURE K

↓ New York City,
Hudson Yards & The Vessel (US)
Maîtrise d'ouvrage / Contracting authority:
Related Companies, Oxford Properties Group
Architectes / Architects: KPF (places and
gardens), Thomas Heatherwick (The Vessel)
Paysagiste / Landscape architects: Nelson
Byrd Woltz Landscape Architects
Conception lumière / Lighting designer:
L'Observatoire International

© Stefano Giovannini

→ Sérignan, Abords de la mairie (FR)
Maîtrise d'ouvrage / Contracting authority:
Ville de Sérignan

© Hugo Da Costa



PAUL™ & PAULETTE™

Projecteurs LED
LED projectors

Compatible avec / with :

Tous nos mâts support projecteurs / all our poles: Structure K, Aiguille, Bermude, Octave

Toutes nos colonnes (éclairage interne ou additionnel) / all our columns (internal or additional lighting): Treille, Creille (GM), Creille qui Pousse

Description

- Gamme de projecteurs carrés (Paul) ou ronds (Paulette), déclinée spécifiquement pour l'éclairage architectural ou l'éclairage routier
- Gamme «Architectural» disponible en 3 tailles différentes et offrant un large panel de couleurs (blancs, blanc dynamique, RGB white)
- Gamme «Routier» disponible en 2 tailles différentes
- Corps et fixation en aluminium
- Garantie 2 ans

Description

- Range of floodlights: square-shape (Paul) or round-shape (Paulette), available for architectural or roadway lighting
- «Architectural» range available in 3 different sizes and offering a large color panel (whites, dynamic white, RGB white)
- «Roadway» range available in 2 different sizes
- Body and mounting fixtures in aluminum
- 2 year guarantee



Modèle / model: Paul



Modèle / model: Paulette

Informations techniques / Technical specifications

| | ARCHITECTURAL | | | ROUTIER / STREET | |
|-----------------------------------|---|---------|---------|---------------------------|---------|
| | S | M | L | M | L |
| Taille / Size | | | | | |
| Nombre de LED / number of LED | 16 | 24 | 36 | 16 | 36 |
| Puissance / Power | 18 W | 27 W | 37 W | 24 W | 37 W |
| Flux sortant / Outflow (3000°K) | 1500 lm | 2300 lm | 3100 lm | 2970 lm | 4165 lm |
| T° de couleur / Color t° | 2200, 2700, 3000, 4000 °K Dynamic white (2200-4000°K), RGB white | | | 2200, 2700, 3000, 4000 °K | |
| IRC / CRI | >70 | | | | |
| Indice de protection / Protection | IP 65 / IK 08 | | | | |
| Classe / Class | I (II possible) | | | | |
| Durée de vie / Lifespan (L80B10) | > 100 000 | | | | |
| Driver | Pilotage DALI, DMX (sur demande / upon request) | | | | |

Photometries / Photometry

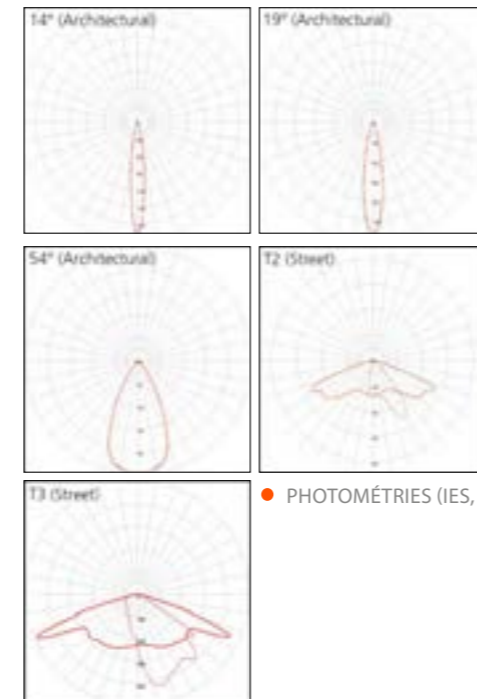

Autres photométries sur demande
Other photometrics upon request

● PHOTOMÉTRIES (IES, LDT) →



· Fixation avec lyre
· Mounting with a yoke

· Fixation avec bras en fonderie orientable
· Mounting with adjustable cast aluminum arm

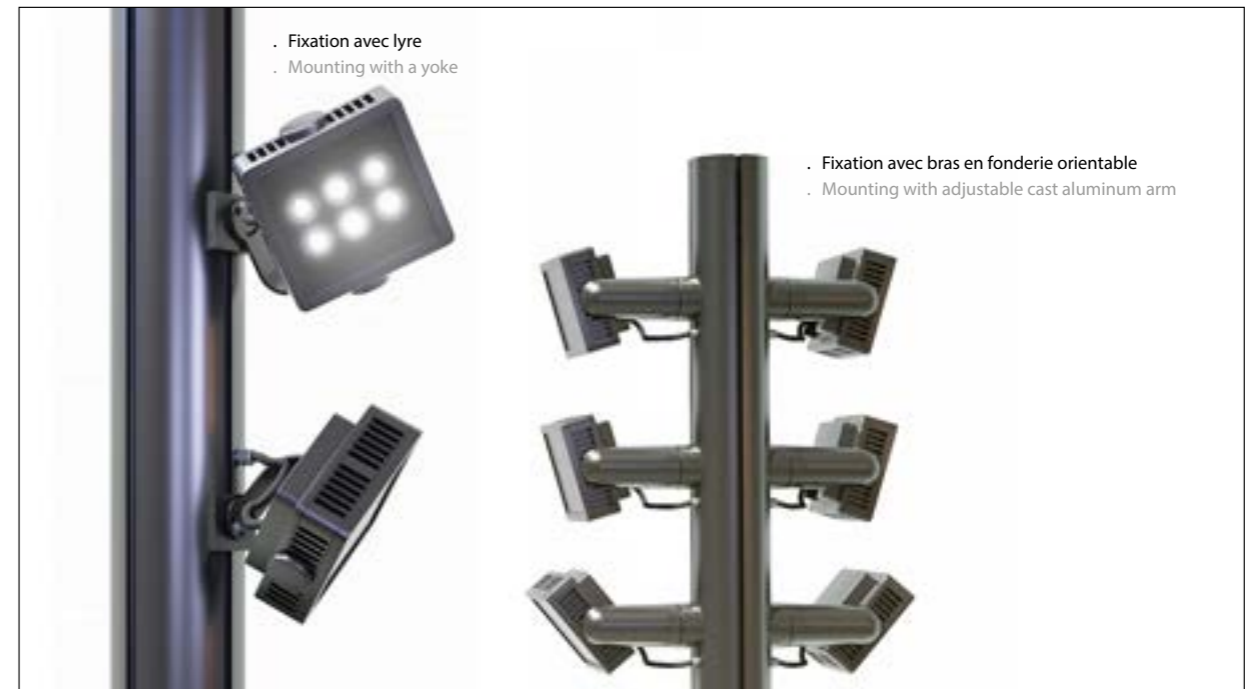

· Fixation avec lyre
· Mounting with a yoke

· Fixation avec bras en fonderie orientable
· Mounting with adjustable cast aluminum arm



Paul & Paulette S



Avec lyre / with yoke
190 x 180 x 100 mm
Avec bras / with arm
270 x 210 x 100 mm

Paul & Paulette M



Avec lyre / with yoke
210 x 200 x 100 mm
Avec bras / with arm
280 x 230 x 100 mm

Paul & Paulette L



Avec lyre / with yoke
260 x 240 x 110 mm
Avec bras / with arm
300 x 270 x 110 mm

PAULETTE XL™

Projecteurs LED
LED projectors

Compatible avec / with :
Tous nos mâts support projecteurs / all our poles: Structure K, Aiguille, Bermude, Octave, Manseng, Mikado, Shiraz

Description

- Projecteur rond, décliné spécifiquement pour l'éclairage architectural ou l'éclairage routier
- Gamme «Architectural» offrant un large pannel de couleurs (blancs, blanc dynamique, RGB white)
- Gamme «Routier»
- Corps et fixation en aluminium
- Garantie 2 ans

Description

- Round-shape floodlight, available for architectural or roadway lighting
- «Architectural» range offering a large color pannel (whites, dynamic white, RGB white)
- «Roadway» range
- Body and mounting fixtures in aluminum
- 2 year guarantee



Modèle / model: Paulette



Modèle / model: Paulette
XL routier / street

Informations techniques / Technical specifications

| Gamme / Range | ARCHITECTURAL | ROUTIER / STREET |
|-----------------------------------|--|---------------------------|
| Nombre de LED / Number of LED | 48 | 32 |
| Puissance / Power | 50 W | 66 W |
| Flux sortant / Outflow (3000°K) | 4200 lm | 8050 lm |
| T° de couleur / Color T° | 2200, 2700, 3000, 4000 °K Dynamic white (2200-3000°K), RGBW | 2200, 2700, 3000, 4000 °K |
| IRC / CRI | >70 | |
| Indice de protection / Protection | IP 65 / IK 08 | |
| Classe / Class | I (II possible) | |
| Durée de vie / Lifespan (L80B10) | > 100 000 | |
| Driver | Pilotable DALI, DMX, programmation horaire (sur demande / upon request) | |

Photometries / Photometry

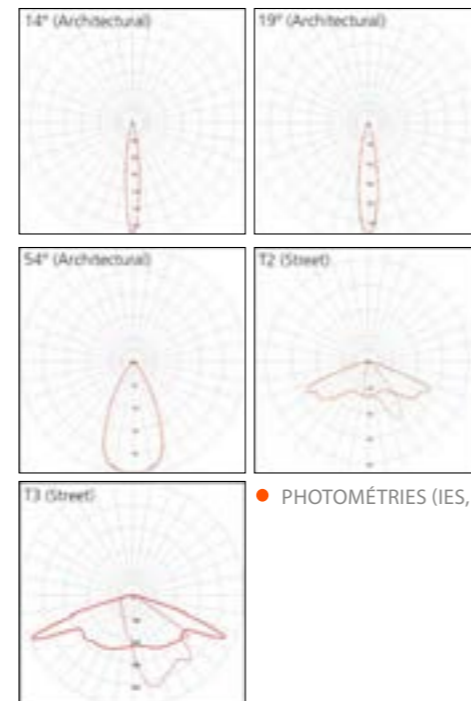

Autres photométries sur demande
Other photometrics upon request

● PHOTOMÉTRIES (IES, LDT) →



Paulette
XL
Lyre /

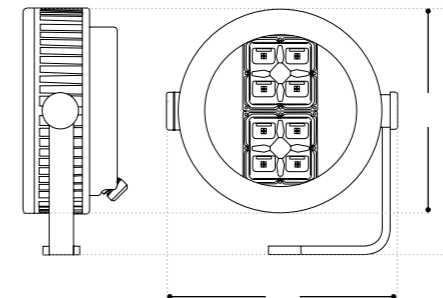

Paulette
XL
Bras /

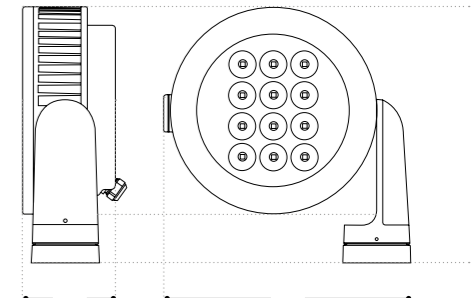

PAUL™ & PAULETTE™ RGBW VERSIONS

Projecteurs LED
LED projectors

Compatible avec / with :

Tous nos mâts support projecteurs / all our poles: Structure K, Aiguille, Bermude, Octave

Toutes nos colonnes (éclairage interne ou additionnel) / all our columns (internal or additional lighting): Treille, Creille (GM), Creille qui Pousse

Description

- Gamme de projecteurs carrés (Paul) ou ronds (Paulette), déclinée spécifiquement pour l'éclairage architectural ou l'éclairage routier
- Gamme «Architectural» disponible en 3 tailles différentes et offrant un large panel de couleurs (blancs, blanc dynamique, RGB white)
- Gamme «Routier» disponible en 2 tailles différentes
- Corps et fixation en aluminium
- Garantie 2 ans

Description

- Range of floodlights: square-shape (Paul) or round-shape (Paulette), available for architectural or roadway lighting
- «Architectural» range available in 3 different sizes and offering a large color panel (whites, dynamic white, RGB white)
- «Roadway» range available in 2 different sizes
- Body and mounting fixtures in aluminum
- 2 year guarantee





Modèle / model: Paul



Modèle / model: Paulette

Informations techniques / Technical specifications

| |  |  |  |
|---|---|---|---|
| Taille / Size | S | M | L |
| Nombre de LED / number of LED | 16 | 24 | 36 |
| Puissance / Power | 16 W | 24 W | 36 W |
| Flux sortant (rouge) / Outflow (red)* | 92 lm | 138 lm | 207 lm |
| Flux sortant (vert) / Outflow (green)* | 636lm | 954lm | 1431lm |
| Flux sortant (bleu) / Outflow (blue)* | 124lm | 186lm | 279lm |
| Flux sortant (blanc) / Outflow (white)* | 480lm | 720lm | 1080lm |
| IRC / CRI | >70 | | |
| Indice de protection / Protection | IP 65 / IK 08 | | |
| Classe / Class | I (II possible) | | |
| Durée de vie / Lifespan (L80B10) | > 100 000 | | |
| Driver | Pilotage DALI, DMX (sur demande / upon request) | | |

*Valeurs de flux indicatives en considérant une tension égale pour chaque couleur

* Indicative outflow values considering the same voltage for each color

Photometries / Photometry

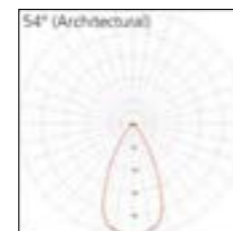
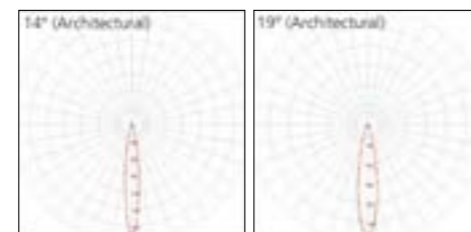

● PHOTOMÉTRIES (IES, LDT) →

Autres photométries sur demande
Other photometrics upon request



- Fixation avec lyre
- Mounting with a yoke

- Fixation avec bras en fonderie orientable
- Mounting with adjustable cast aluminum arm

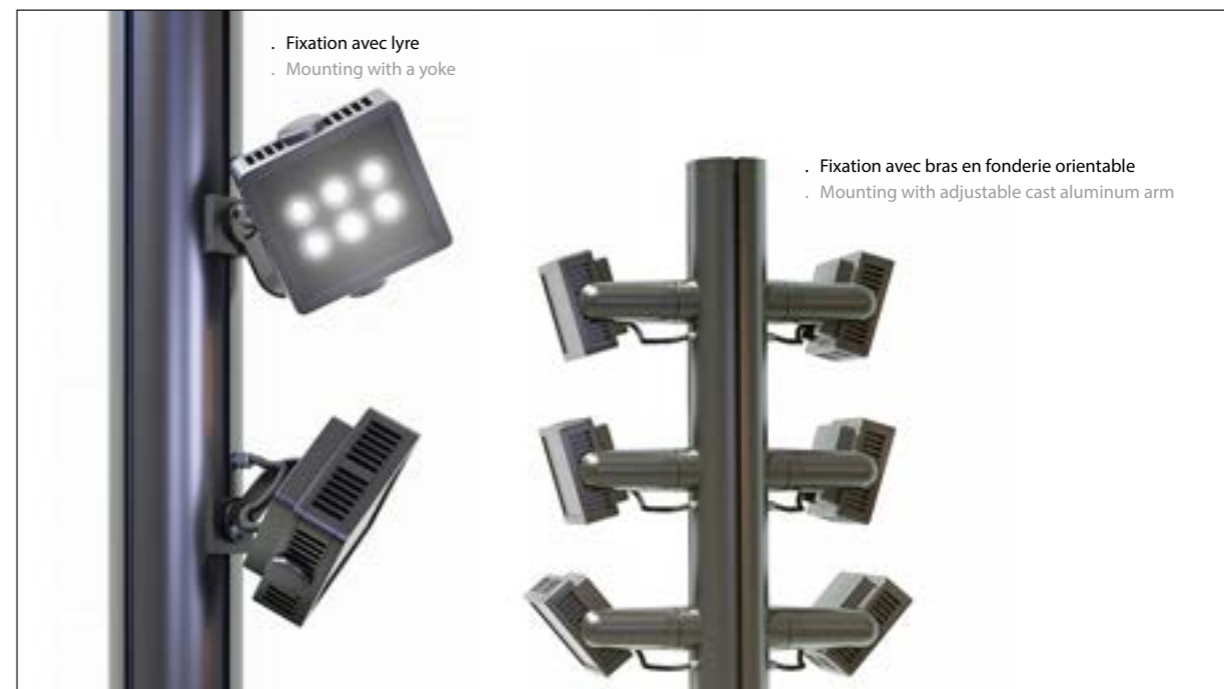

- Fixation avec lyre
- Mounting with a yoke

- Fixation avec bras en fonderie orientable
- Mounting with adjustable cast aluminum arm

Paul & Paulette S



Avec lyre / with yoke
190 x 180 x 100 mm
Avec bras / with arm
270 x 210 x 100 mm

Paul & Paulette M



Avec lyre / with yoke
210 x 200 x 100 mm
Avec bras / with arm
280 x 230 x 100 mm

Paul & Paulette L



Avec lyre / with yoke
260 x 240 x 110 mm
Avec bras / with arm
300 x 270 x 110 mm



MAGIC™

Luminaire LED
LED luminaire

Compatible avec / with :
Ceramic, Nerello, Mauzac, Rovello, Zanello, Marsanne, Roussanne, Techni-Tram, Terret

Hauteur max. préconisée / Max. height recommended : 5 m

Description

- . Corps en fonderie d'aluminium
- . Dimensions : Ø250 x 83 mm
- . Eclairage par 30 LEDs
- . Entrée de câble par connecteur
- . Verre extra-plat
- . Dissipateur thermique et driver LED intégrés
- . Certifications : CE, CSA/UL
- . Garantie 2 ans

Description

- . Body made of die-cast aluminum
- . Dimensions: Ø250 x 83 mm
- . 30 LEDs lighting
- . Cable entry through fast connector
- . Flat clear glass
- . Integrated LED driver and heat sink
- . Certifications: CE, CSA/UL
- . 2 year guarantee

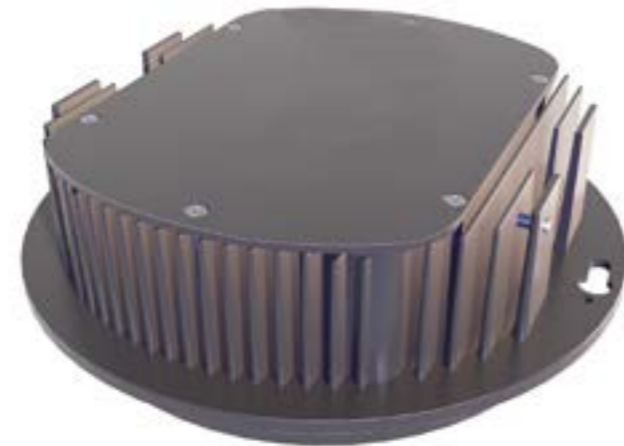
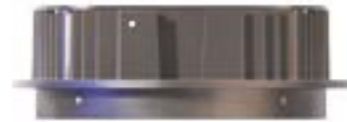

Informations techniques / Technical specifications

| | |
|-----------------------------------|---|
| Indice de protection / Protection | IP 65 / IK 08 |
| Classe / Class | I (II possible) |
| Puissance / Power | 35 W |
| Flux sortant / Outflow (3000°K) | 3591 lm |
| T° de couleur / Color t° | 2200, 2700, 3000, 4000 °K |
| IRC / CRI | >70 |
| Durée de vie / Lifespan (L80B10) | >109 000 |
| Driver | Pilotage DALI, 0-10 V (sur demande / upon request) |

Photométries / Photometry

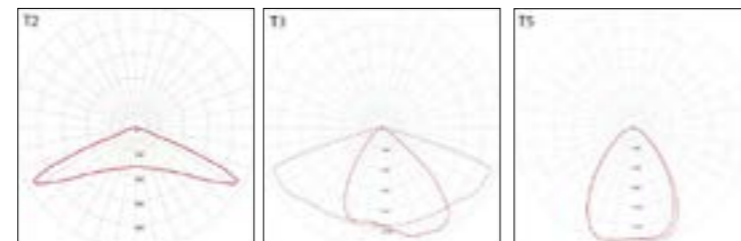

● PHOTOMÉTRIES (IES, LDT) →

