



We shall retain full intellectual property to designs and documentation created for this specific project ; this data shall not be disclosed nor used without our express consent in writing. Legal action will be taken in the event of any reproduction or other violation of our property rights.



**Aluminum made
Entirely Weld-free**

Height 9 to 12 m

Pole

- . Exclusive aluminum profile with internal structure
- . Trapezoid section:
200 x 258 x 302 mm or 140 x 180 x 210 mm
- . Created for floodlights mounted either to the pole or integrated inside
- . Possibility of straight or tilted poles, with or without arm

Access door

- . Flush, interchangeable
- . Opening 500 x 245 mm or 500 x 128 mm
- . At 600 mm from the base
(Other heights possible)

Baseplate (with insulating rings)

- . Made of die-cast aluminum
- . Dimensions 400 x 400 mm
- . Fixing distance 300 x 300 mm

Finish

- . Polyester powder coating
- . RAL colors or special finish
- . Natural anodization (20 microns)

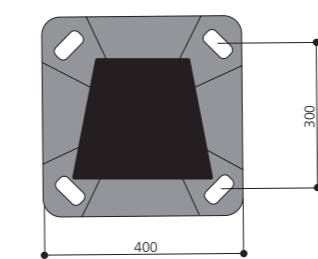
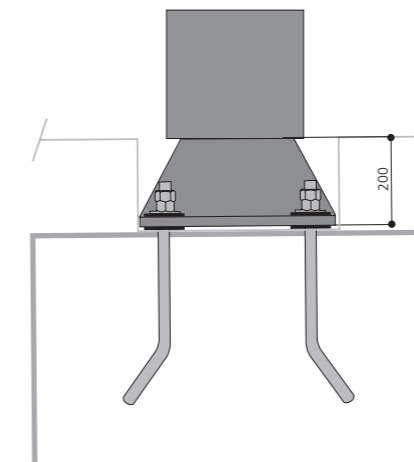
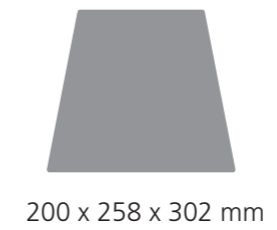
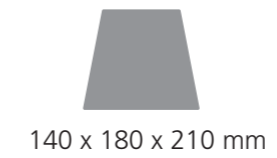

We shall retain full intellectual property to designs and documentation created for this specific project ; this data shall not be disclosed nor used without our express consent in writing. Legal action will be taken in the event of any reproduction or other violation of our property rights.

PAUL™ & PAULETTE™

Projecteurs LED
LED projectors

Compatible avec / with :

Tous nos mâts support projecteurs / all our poles: Structure K, Aiguille, Bermude, Octave

Toutes nos colonnes (éclairage interne ou additionnel) / all our columns (internal or additional lighting): Treille, Creille (GM), Creille qui Pousse

Description

- Gamme de projecteurs carrés (Paul) ou ronds (Paulette), déclinée spécifiquement pour l'éclairage architectural ou l'éclairage routier
- Gamme «Architectural» disponible en 3 tailles différentes et offrant un large panel de couleurs (blancs, blanc dynamique, RGB white)
- Gamme «Routier» disponible en 2 tailles différentes
- Corps et fixation en aluminium
- Garantie 2 ans

Description

- Range of floodlights: square-shape (Paul) or round-shape (Paulette), available for architectural or roadway lighting
- «Architectural» range available in 3 different sizes and offering a large color panel (whites, dynamic white, RGB white)
- «Roadway» range available in 2 different sizes
- Body and mounting fixtures in aluminum
- 2 year guarantee



Modèle / model: Paul



Modèle / model: Paulette

Informations techniques / Technical specifications

	ARCHITECTURAL			ROUTIER / STREET	
	S	M	L	M	L
Taille / Size					
Nombre de LED / number of LED	16	24	36	16	36
Puissance / Power	18 W	27 W	37 W	24 W	37 W
Flux sortant / Outflow (3000°K)	1500 lm	2300 lm	3100 lm	2970 lm	4165 lm
T° de couleur / Color t°	2200, 2700, 3000, 4000 °K Dynamic white (2200-4000°K), RGB white			2200, 2700, 3000, 4000 °K	
IRC / CRI	>70				
Indice de protection / Protection	IP 65 / IK 08				
Classe / Class	I (II possible)				
Durée de vie / Lifespan (L80B10)	> 100 000				
Driver	Pilotage DALI, DMX (sur demande / upon request)				

Photometries / Photometry

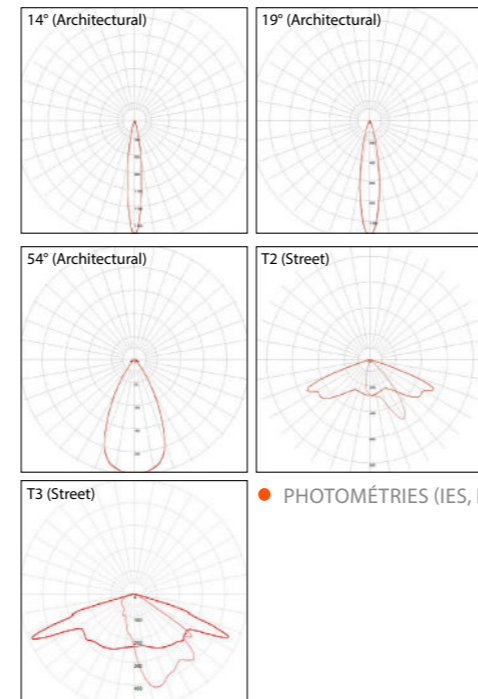

Autres photométries sur demande
Other photometrics upon request

● PHOTOMÉTRIES (IES, LDT) →

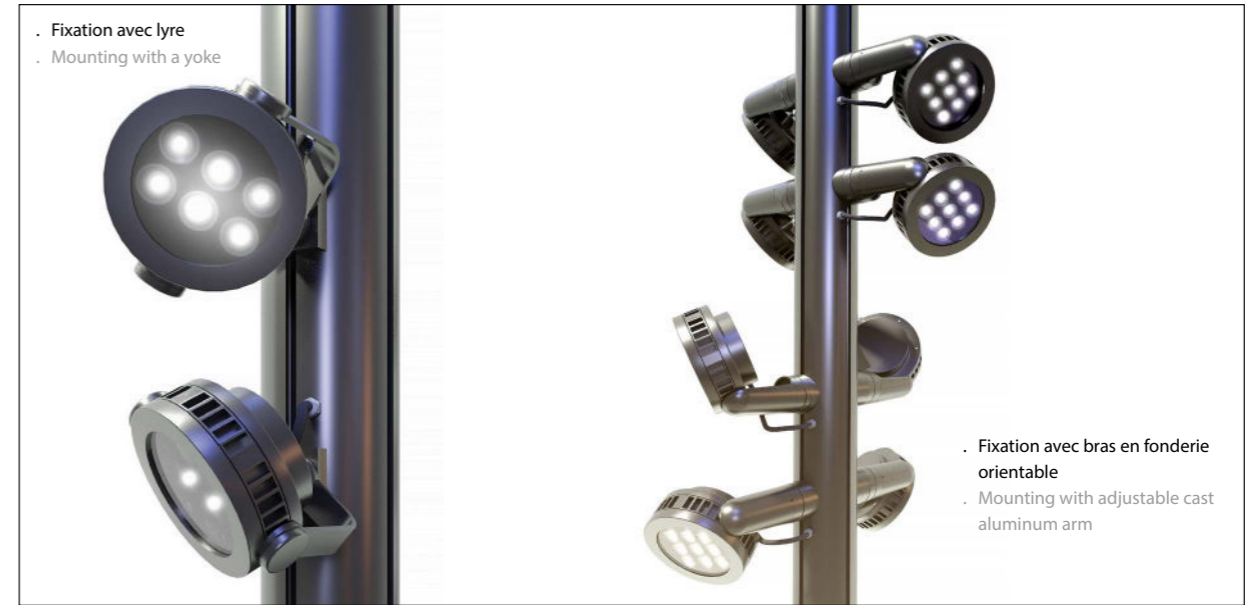

- Fixation avec lyre
- Mounting with a yoke

- Fixation avec bras en fonderie orientable
- Mounting with adjustable cast aluminum arm

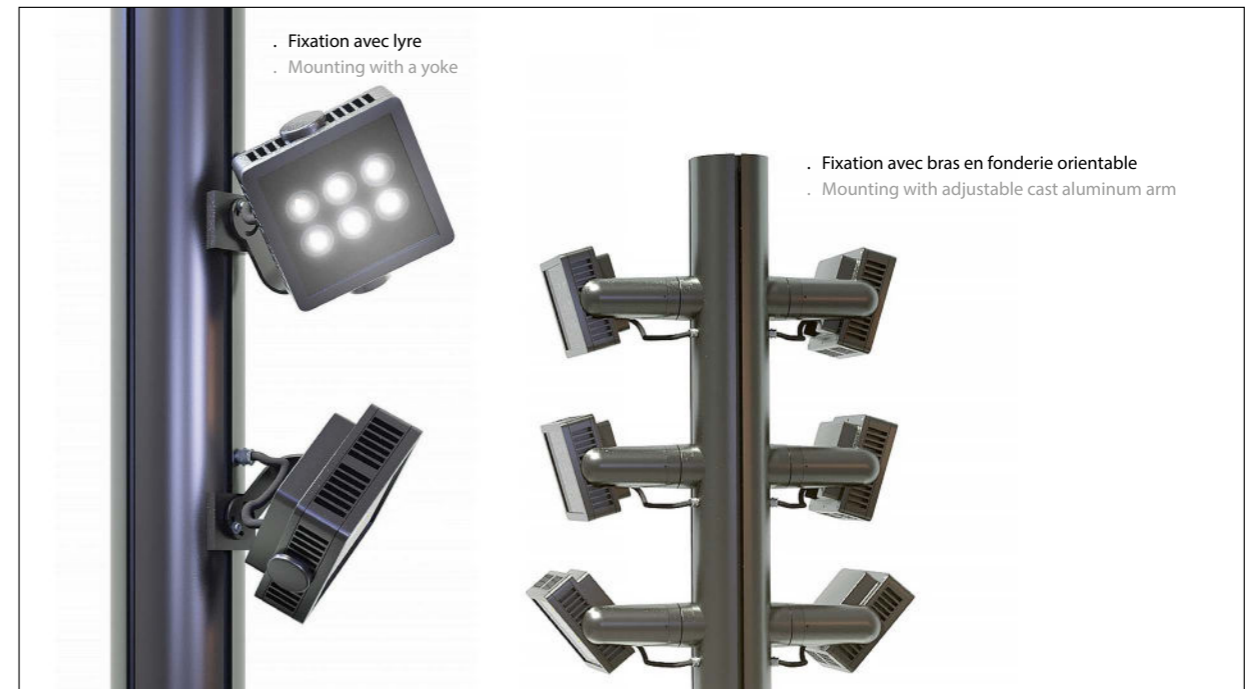

- Fixation avec lyre
- Mounting with a yoke

- Fixation avec bras en fonderie orientable
- Mounting with adjustable cast aluminum arm

Paul & Paulette S

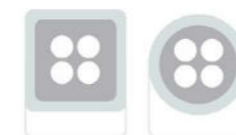

Avec lyre / with yoke
190 x 180 x 100 mm
Avec bras / with arm
270 x 210 x 100 mm

Paul & Paulette M

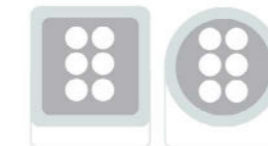

Avec lyre / with yoke
210 x 200 x 100 mm
Avec bras / with arm
280 x 230 x 100 mm

Paul & Paulette L

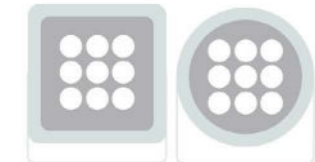

Avec lyre / with yoke
260 x 240 x 110 mm
Avec bras / with arm
300 x 270 x 110 mm

PAUL™ & PAULETTE™ RGBW VERSIONS

Projecteurs LED
LED projectors

Compatible avec / with :

Tous nos mâts support projecteurs / all our poles: Structure K, Aiguille, Bermude, Octave

Toutes nos colonnes (éclairage interne ou additionnel) / all our columns (internal or additional lighting): Treille, Creille (GM), Creille qui Pousse

Description

- Gamme de projecteurs carrés (Paul) ou ronds (Paulette), déclinée spécifiquement pour l'éclairage architectural ou l'éclairage routier
- Gamme «Architectural» disponible en 3 tailles différentes et offrant un large panel de couleurs (blancs, blanc dynamique, RGB white)
- Gamme «Routier» disponible en 2 tailles différentes
- Corps et fixation en aluminium
- Garantie 2 ans

Description

- Range of floodlights: square-shape (Paul) or round-shape (Paulette), available for architectural or roadway lighting
- «Architectural» range available in 3 different sizes and offering a large color panel (whites, dynamic white, RGB white)
- «Roadway» range available in 2 different sizes
- Body and mounting fixtures in aluminum
- 2 year guarantee



Modèle / model: Paul



Modèle / model: Paulette

Informations techniques / Technical specifications

	S	M	L
Taille / Size			
Nombre de LED / number of LED	16	24	36
Puissance / Power	16 W	24 W	36 W
Flux sortant (rouge) / Outflow (red)*	92 lm	138 lm	207 lm
Flux sortant (vert) / Outflow (green)*	636lm	954lm	1431lm
Flux sortant (bleu) / Outflow (blue)*	124lm	186lm	279lm
Flux sortant (blanc) / Outflow (white)*	480lm	720lm	1080lm
IRC / CRI	>70		
Indice de protection / Protection	IP 65 / IK 08		
Classe / Class	I (II possible)		
Durée de vie / Lifespan (L80B10)	> 100 000		
Driver	Pilotage DALI, DMX (sur demande / upon request)		

*Valeurs de flux indicatives en considérant une tension égale pour chaque couleur

* Indicative outflow values considering the same voltage for each color

Photometries / Photometry

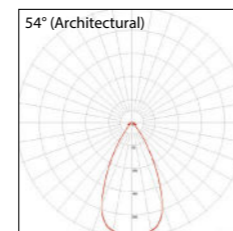
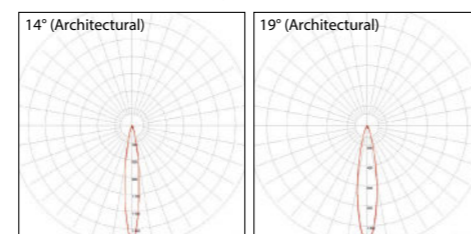

● PHOTOMÉTRIES (IES, LDT) →

Autres photométries sur demande
Other photometrics upon request

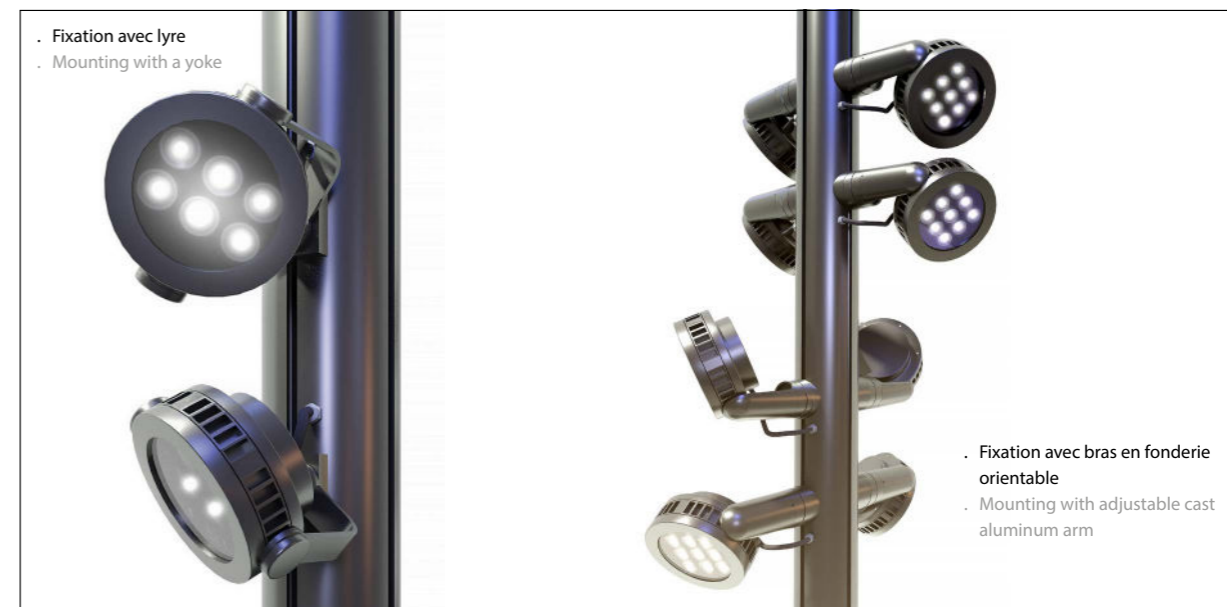

- Fixation avec lyre
- Mounting with a yoke

- Fixation avec bras en fonderie orientable
- Mounting with adjustable cast aluminum arm

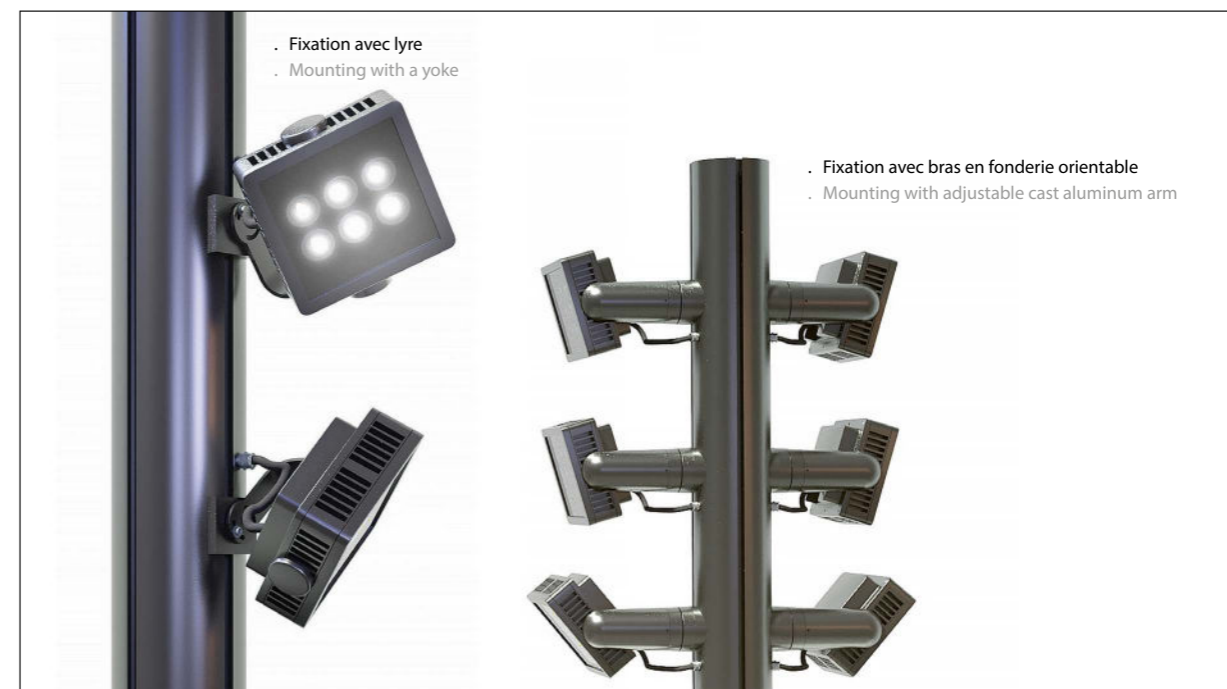

- Fixation avec lyre
- Mounting with a yoke

- Fixation avec bras en fonderie orientable
- Mounting with adjustable cast aluminum arm

Paul & Paulette S

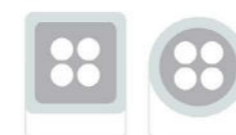

Avec lyre / with yoke
190 x 180 x 100 mm
Avec bras / with arm
270 x 210 x 100 mm

Paul & Paulette M

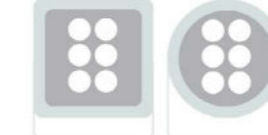

Avec lyre / with yoke
210 x 200 x 100 mm
Avec bras / with arm
280 x 230 x 100 mm

Paul & Paulette L

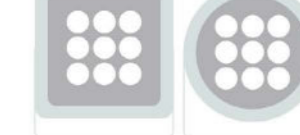

Avec lyre / with yoke
260 x 240 x 110 mm
Avec bras / with arm
300 x 270 x 110 mm

PAULETTE XL™

Projecteurs LED
LED projectors

Compatible avec / with :
Tous nos mâts support projecteurs / all our poles: Structure K, Aiguille, Bermude, Octave, Manseng, Mikado, Shiraz

Description

- Projecteur rond, décliné spécifiquement pour l'éclairage architectural ou l'éclairage routier
- Gamme «Architectural» offrant un large pannel de couleurs (blancs, blanc dynamique, RGB white)
- Gamme «Routier»
- Corps et fixation en aluminium
- Garantie 2 ans

Description

- Round-shape floodlight, available for architectural or roadway lighting
- «Architectural» range offering a large color pannel (whites, dynamic white, RGB white)
- «Roadway» range
- Body and mounting fixtures in aluminum
- 2 year guarantee



Modèle / model: Paulette
XL Architectural



Modèle / model: Paulette
XL routier / street

Informations techniques / Technical specifications

Gamme / Range	ARCHITECTURAL	ROUTIER / STREET
Nombre de LED / Number of LED	48	32
Puissance / Power	50 W	66 W
Flux sortant / Outflow (3000°K)	4200 lm	8050 lm
T° de couleur / Color T°	2200, 2700, 3000, 4000 °K Dynamic white (2200-3000°K), RGBW	2200, 2700, 3000, 4000 °K
IRC / CRI	>70	
Indice de protection / Protection	IP 65 / IK 08	
Classe / Class	I (II possible)	
Durée de vie / Lifespan (L80B10)	> 100 000	
Driver	Pilotable DALI, DMX, programmation horaire (sur demande / upon request)	

Photometries / Photometry

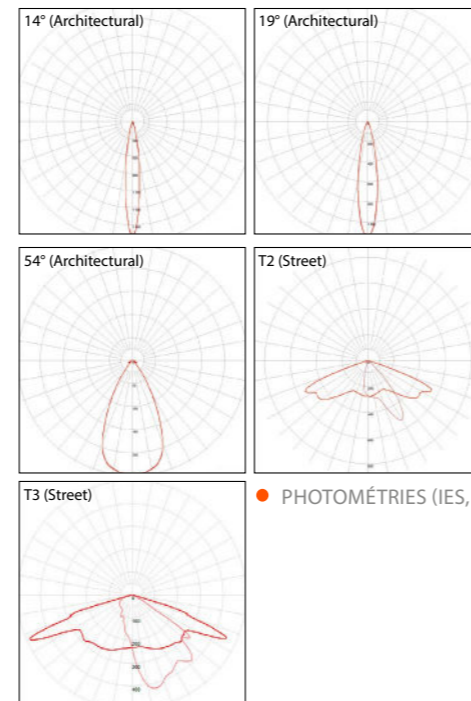

Autres photométries sur demande
Other photometrics upon request

● PHOTOMÉTRIES (IES, LDT) →



Fixation avec lyre
Mounting with a yoke



Fixation avec bras en fonderie orientable
Mounting with adjustable cast aluminum arm

Paulette
XL
Lyre /
Yoke

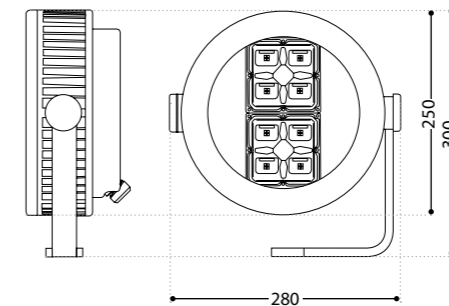

Paulette
XL
Bras / Arm

